

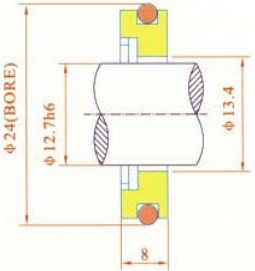









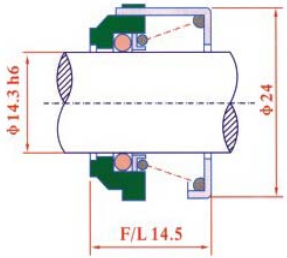

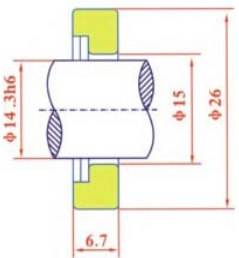

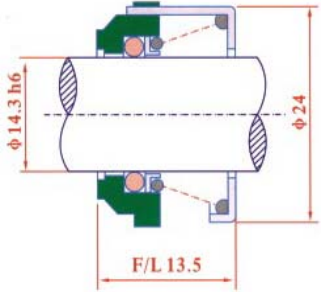

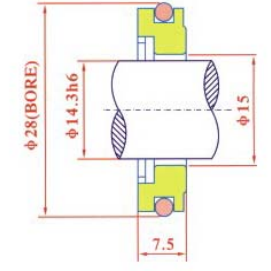

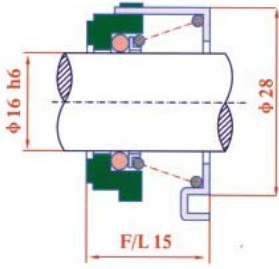

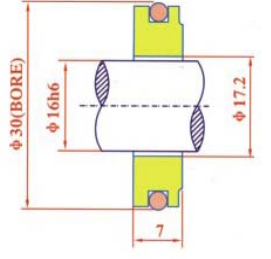

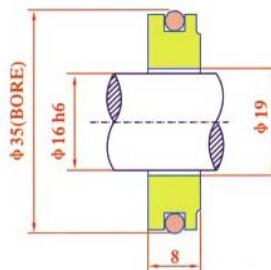

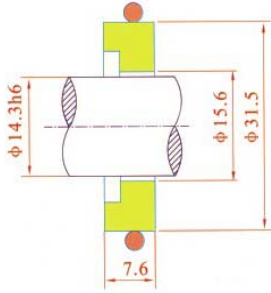

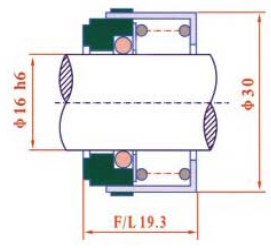

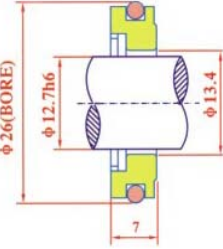

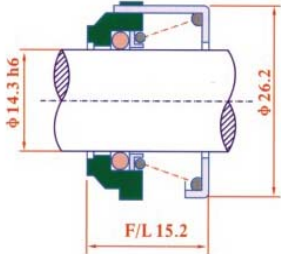

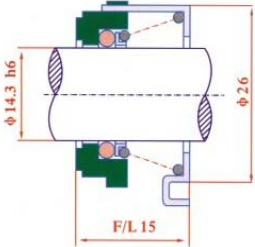

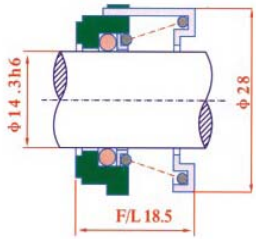

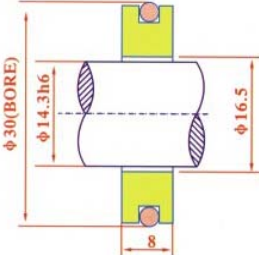

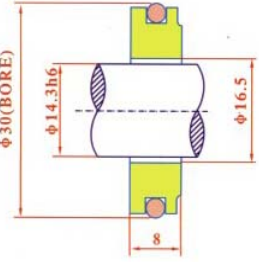

Compressor seals Catalogue

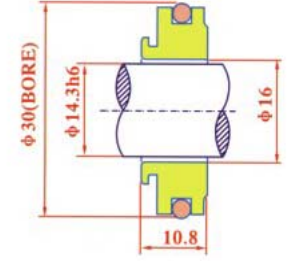
HACM CODE	Discription	Picture	Drawing
MACHANICAL SHAFT SEAL			
HC.08A.0001	For Mitsubishi(三菱)NL/SA, Panasonic(松下)compressor steel seat		
HC.08A.0002	For Sanden(三电)SD709		
HC.08A.0003	For Diesel kiki BH//DKS 13G/DKS 17G Steel Seat		
HC.08A.0004	For Sanden(三电)SD708		

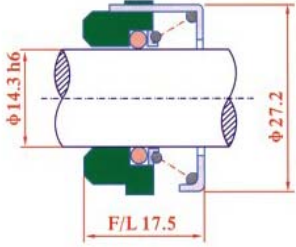
HACM CODE	Discription	Picture	Drawing
HC.08A.0005	For Sanden(三电)SD708 Steel Seat		
HC.08A.0006	For Nippon Denso(日本电装)TV12C/14C,TV12ES/TV12SC		
HC.08A.0007	For Nippon Denso(日本电装)TV12C/14C, TV12EC/TC12SC Steel Seat		
HC.08A.0008	For Nippon Denso(日本电装)10PA25C/10PA20C Steel Seat		
HC.08A.0009	FOR GM(通用)a6/r4,Ford(福特)hr980 ceramic seal seat		
HC.08A.0010	For Nippon Denso(日本电装)10PA25C/10PA20C		

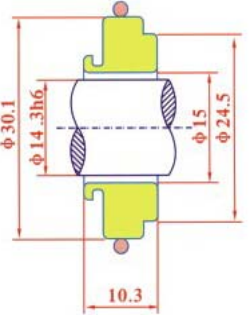

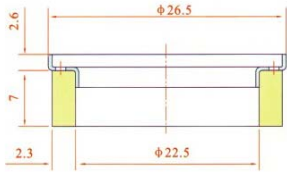





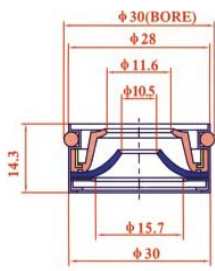

HACM CODE	Discription	Picture	Drawing
HC.08A.0011	For BITZER(比泽尔新款)Compressor		
HC.08A.0012	For Chrysler(克莱斯勒)rv12carbon seal compressor		
HC.08A.0013	For Chrysler(克莱斯勒)rv12carbon seal compressor		
HC.08A.0014	For York(约克)6 bolt(7/32")compressor		
HC.08A.0015			
HC.08A.0016	For Mats NL/SA, Mits FX105v, Sanden(三电)SD505/507Mini,Sanden(三电)SDTR70/90/105,Compressor		

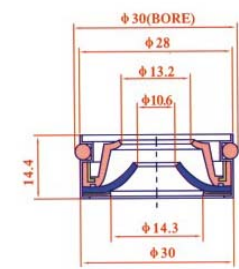
HACM CODE	Discription	Picture	Drawing
HC.08A.0017	For Mats NL/SA, Mits FX105v, Sanden(三电)SD505/507Mini,Sanden(三电)SDTR70/90/105,CompressorF		
HC.08A.0018	FOR Chrysler (克莱斯勒) C171/A590,Ford(福特)FS6,Nippon Denso(日本电装)10P13/10P15/10P08E/P127/134/148/6E171		
HC.08A.0019	For Nippon Denso (日本电装) TV/10C-Aftermarket		
HC.08A.0020	ForFord(福特)FS6/6P/6E/10P,Nippon Denso(日本电装)10P17/10P08E/10P13/10P15/10PA17/6P127A6P127B/6P134/6P148,Extractor LIP		
HC.08A.0021	FOR Chrysler (克莱斯勒) C171/A590,Ford(福特)FS6,Nippon Denso(日本电装)10P13/10P15/10P08E/P127/134/148/6E171		
HC.08A.0022	For Nippon Denso (日本电装) TV/10C-Aftermarket steel seat		

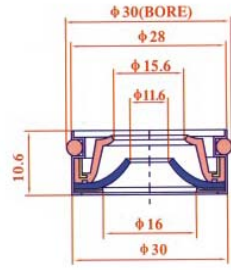
HACM CODE	Discription	Picture	Drawing
HC.08A.0023	FOR Nippon Denso(日本电装) 10p17/10P08E/10P13		
HC.08A.0024	For Ford(福特) HR980, GM(通用)A6/R4, Sanden(三电)SD508/510,York YA12/15,Seiko Seiki SS148PB/170PSS/811PB5		
HC.08A.0025	For Ford(福特) HR980, GM(通用)A6/R4, Sanden(三电)SD508/510,York YA12/15,Seiko Seiki SS148PB/170PSS/811PB5		
HC.08A.0026	For Sanden(三电)sd507/508 min felt wiper ring with retainer		
HC.08A.0027	For Sanden(三电)sd708/709/ two piece felt wiper ring with retainer		

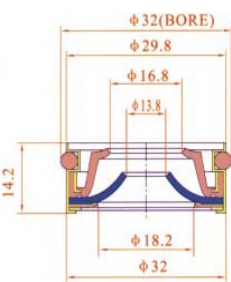
HACM CODE	Discription	Picture	Drawing
HC.08A.0028	For Sanden(三电)sd507/508/510 felt wiper ring with retainer		
LIP TYPE SHAFT SEAL			
HC.08A.0029	For Panasonic(松下)Lip Seal		
HC.08A.0030	FOR Saden(三电)505/507, TR70, TR90/TR105, Mitsubishi(三菱)MSC90C, MSC105C, FX80/FX105V, SH942/K600,H (本田) K600, R134工, Compressor		
HC.08A.0031	For Saden(三电)SD508,708,709,7HB,7H15,7B10,1020		
HC.08A.0032	For Saden(三电)508/5H14		

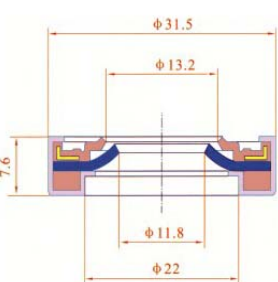
HACM CODE	Discription	Picture	Drawing
HC.08A.0033	For Saden(三电)SD708/709		
HC.08A.0034	For Nippon Denso(日本电装)TV12/14C, Calsonic(日本康奈克)Nissan Cefiro(尼桑)A30., A32ND 10P R134a,compressor		
HC.08A.0035	For Denso(电装)TV12/TV14R134a,compressor		
HC.08A.0036	For Nippon Denso(日本电装)10PA15C/10PA17C/10PA20C, DKS CV11A, Denso(日本电装)10PA15/10PA17 R134a,compressor		
HC.08A.0037	For Nippon Denso(日本电装)10P08E, Chrysler(克莱斯勒)6C/6CA17, 6P17CR134工, compressor		
HC.08A.0038	For Saden(三电)508直改		

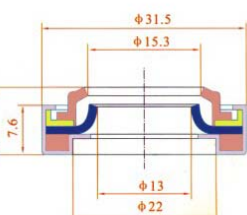
HACM CODE	Discription	Picture	Drawing
HC.08A.0039	For Diese kiki DKS16H, R134a,compressor		
HC.08A.0040	For DKS11D/14D,R134a,compressor		
HC.08A.0041	For Seiko Seiki(日本精工精机) SS170ZEXEL(吉克赛尔)DKS 16H,SD709,R12,R134a,compressor		
HC.08A.0042	For TM131 DIESEL KIKI TM31 DKS32		
HC.08A.0043	For GM(通用)DA6/HT6/HR6HE/R4/V5,NIHON NVR14OS double lips		
HC.08A.0044	For GM(通用)THT6/HU6 large shaft		



HACM CODE	Discription	Picture	Drawing
HC.08A.0045	For GM(通用)HD6/HT6/HR6/HR6HE/R4/V5,NIHON NVR140SR134a,compressor double lips		
HC.08A.0046	For GM(通用)DA6/HD6/HR6/HR6HE/R4/V5,CALSON IC V5-15F/V5-14G,R134a,compressor		
HC.08A.0047	Audi(奥迪), Golden Dragon(厦门金龙)		
HC.08A.0048	For GM(通用)da6/hr6/v5/r4 double lips seal		
HC.08A.0049	For TM131 DIESEL KIKI		
HC.08A.0050	For Nippon Denso(日本电装)10S30B/10S30B/10S30C 1020B/10S20C R134a,compressor		

HACM CODE	Discription	Picture	Drawing
HC.08A.0051	For Toyota(丰田)Automobile R134a		
LID SHAFT WITH RUBBER-MOUNTED			
HC.08A.0052			
HC.08A.0053	For Ford(福特)FS10/FX15/VF2 R134a,compressor		
HC.08A.0054	For Mitsubishi(三菱)MSC90C,MSC105C OEM TYPE New Panasonic R134a,compressor		
HC.08A.0055	For Mitsubishi(三菱)MSC90C,MSC105C OEM TYPE New Panasonic R134a,compressor		

HACM CODE	Discription	Picture	Drawing
HC.08A.0056	For Saden(三电)TR 70 OEM TYPE R134a,compressor		
HC.08A.0057	For Daewoo(大字)V5 OEM,SOME GM(通用)V5/V7 OEM,R134a,compressor		
HC.08A.0058			
HC.08A.0059			
HC.08A.0060			

HACM CODE	Discription	Picture	Drawing
HC.08A.0061			
HC.08A.0062	For DKS-17VS/V7Mitsubishi(三菱)NSO MSC 90/105,Calsonic(日本康奈可)VT		
HC.08A.0063	For GM(通用)V5		
HC.08A.0064	For Volkswage(大众), Saden(三电)		
HC.08A.0065	For Saden(三电)SD7SB,Passat B5(帕萨特)Benz(奔驰), BMW (

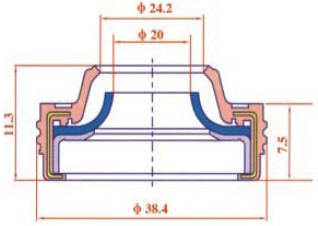
HACM CODE	Discription	Picture	Drawing
HC.08A.0066	ROR Hitach (日立) MJS170 R134a,compressor		
HC.08A.0067	For TM08-16 R134a,compressor		
HC.08A.0068	For Nippon Denso(日本电装)7sbu16 R134a,compressor		
HC.08A.0069	ForDK CA11A,Nippon Denso(日本电装)10PA15/17/20 OEM SEALR134a,compressor		
HC.08A.0070	For 32c,Nippon Denso(日本电装)10pa 30c New type compressor		

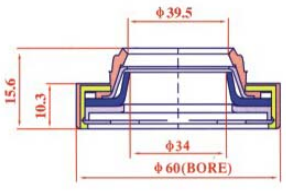
HACM CODE	Discription	Picture	Drawing
HC.08A.0071	For Bus		
HC.08A.0072			

SEALING WASHERS

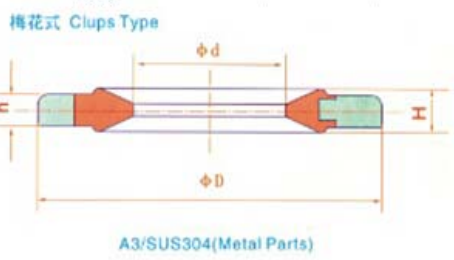

Rubber:NBR/HNBR
Frame work:A3







HACM Code	d	D	H	h
-----------	---	---	---	---

HC.08B.0001	15	29.5	4	3
-------------	----	------	---	---









HC.08B.0002	15.2	28	2	1.4
-------------	------	----	---	-----



HACM CODE	Discription			Picture	Drawing
HC.08B.0003	19.6	29.7	2	1.5	
HC.08B.0004	16.8	31.5	2	1.4	
HC.08B.0005	15.5	30	7.5	5.3	
HC.08B.0006	15.5	30	4.8	3.8	
HC.08B.0007	15	30.5	4.2	3	
HC.08B.0008	15.4	23.7	1.9	1.3	

HACM CODE	Discription			Picture	Drawing	
HC.08B.0009	14.4	23.7		<p>OD:23.7mm ID:14.4mm</p>		
HC.08B.0010	8.4	16	2	1.4	<p>OD:16mm ID:8.4mm</p>	
HC.08B.0011	11.2	19.2	2.2	1.4	<p>OD:19.2mm ID:11.2mm</p>	
HC.08B.0012	17.4	25.4	2.2	1.4	<p>OD:25.4mm ID:17.4mm</p>	
HC.08B.0013	8.3	14.2			<p>OD:14.2mm ID:8.3mm</p>	
HC.08B.0014	11.45	17.25			<p>OD:17.25mm ID:11.45mm</p>	

HACM CODE	Discription		Picture	Drawing
HC.08B.0015	14	19.8		
HC.08B.0016	17.7			
HC.08B.0017	14.7			
HC.08B.0018	12.1			
HC.08B.0019	15.2			
HC.08B.0020	14.7			

HACM CODE	Discription	Picture	Drawing
-----------	-------------	---------	---------

HC.08B.0021	21.2		
HC.08B.0022	17.7		



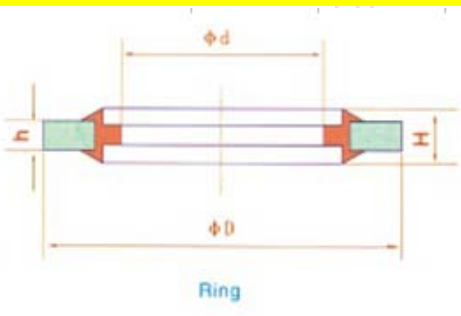

Ring gasket



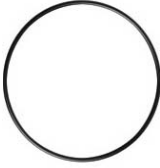

FOR V5
R4 HD6
R12/R134
a







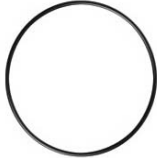
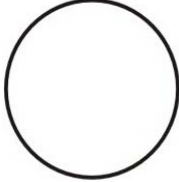







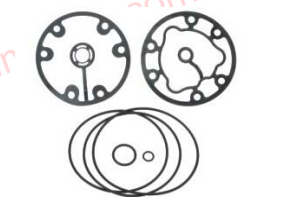
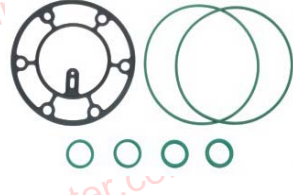

Rubber(NBR/HNBR)
Frame work(A3)









HACM Code	d	D	H	h
HC.08B.0023	14.8	23	2.7	2
HC.08B.0024	10.7	18.8	2.7	2
HC.08B.0025	14.7	22	2.4	1.5
HC.08B.0026	13.5	24	2.6	1.5
HC.08B.0027	8.7	14	1.8	1
HC.08B.0028	11.4	17	1.8	1
HC.08B.0029	15	22	2.1	1.3
HC.08B.0030	18.6	26	2.4	1.6
HC.08B.0031	24	32	2.4	1.6
HC.08B.0032	30.2	39.5	2.6	1.8

HACM CODE	Discription	Picture	Drawing
COMPRESSOR GASKET			
HC.08C.0001	10P17C		10P17C
HC.08C.0002	10P20C		10P20C
HC.08C.0003	32C		32C
HC.08C.0004	709		709
HC.08C.0005	SUZUKI		SUZUKI

HACM CODE	Discription	Picture	Drawing
HC.08C.0006	V5		V5
HC.08C.0007	10PA17C		10PA17C
HC.08C.0008	15C/13		15C/13C
HC.08C.0009	508		508
HC.08C.0010	Ford		Ford
HC.08C.0011	ss96		SS96

HACM CODE	Discription	Picture	Drawing
SEALING WASHETS			
HC.08D.0001	32C		
HC.08D.0002	508		
HC.08D.0003	709		
HC.08D.0004	7B10/706		
HC.08D.0005	FS10		
HC.08D.0006	HT6		
HC.08D.0007	V5		

HACM CODE	Discription	Picture	Drawing
HC.08D.0008	SD508		
HC.08D.0009	SD709		
HC.08D.0010	metal gasket Chrysler ID:11.51mm		
HC.08D.0011	metal gasket Chrysler ID:16mm		
HC.08D.0012	metal gasket bottle block Chrysler hole:0.377mm		
HC.08D.0013	metal gasket Chrysler hole:0.437mm		
HC.08D.0014	metal gasket Chrysler ID:13.59mm		
			

HACM CODE	Discription	Picture	Drawing
HC.08D.0015	Chrysler ID:14.3mm		
HC.08D.0016	metal gasket Chrysler discharge port 克莱斯勒金属垫片: 0.377导正孔 克莱斯勒金属垫片: 6C17释放端 0.625正孔		
HC.08D.0017	metal gasket Chrysler condenser manifold 克莱斯勒金属垫片 多头冷凝器		
HC.08D.0018	metal gasket Chrysler suction line 克莱斯勒金属垫片吸入管		
HC.08D.0019	metal gasket A590/C171 Chrysler suction/discharge line 克莱斯勒金属垫片吸入/释放端		
HC.08D.0020	metal gasket Chrysler 克莱斯勒金属垫片		
HC.08D.0021	metal gasket Chrysler manifold to expansion valve 克莱斯勒至膨胀阀的液体管		
HC.08D.0022	metal gasket Chrysler TXV to Expansion valve(gold valve) 克莱斯勒扩张阀、金属阀		

HACM CODE	Discription	Picture	Drawing
HC.08D.0023	metal gasket Chrysler TXV to Expansion valve(gold to black valve) 克莱斯勒扩张阀、金属阀		
HC.08D.0024	metal gasket Chrysler to Expansion valve 克莱斯勒至膨胀阀的液体管		
HC.08D.0025	metal gasket ChryslerRV2 discharge port 克莱斯勒RV2释放端		
HC.08D.0026	metal gasket ChryslerRV2 suction port 克莱斯勒RV2吸入端		
HC.08D.0027	metal gasket Chrysler 克莱斯勒垫圈		
HC.08D.0028	长款嵌入式导正销		
HC.08D.0029	短款嵌入式导正销		